



PR 5610/05 Ex-Terminal



- "Plug and play"-functionality: direct control of all X5 controller without any programming
- Easy connection via serial interface
- EEx ib IIC T4 approval for operation inside hazardous area
- Characters height 12mm
- Scratch-resistant display with anti-reflective coating
- Robust metal housing with IP 65 front for panel mounting
- IP 65 stainless steel housing (option)

The Ex-Terminal is a remote display (slave) for indication and control of the system controller of the X-Family.

Full control in hazardous area

For the use of electronics in hazardous areas a lot of guidelines and regulations have to be followed. This means very often a compromise of functionality, applications and comfort.

Sartorius offers with the Ex-Terminal a comfortable and very easy solution. So from now on production processes in hazardous become more and more effective.

Powerful combination

The Ex-Terminal is suitable for all applications with the system controllers of the X-Family in the hazardous area. For that the system controllers will be located in the safe area. The remote Ex-Terminal will be connected to the controller via a barrier and installed in the hazardous area. The operation of the

controller and the Ex-Terminal are identical.

The direct connection and plug and play functionality are all already implemented in all system controllers. The Ex-Terminal can be directly connected without any programming. Additionally to the Ex-Terminal Sartorius offers a IP 65 housing in stainless steel, an intrinsically safe data interface and power supply for the Ex-Terminal and a cable to connect the Ex-Terminal to the interface.

По вопросам продаж и поддержки обращайтесь:

Астана+7(7172)727-132, Волгоград(844)278-03-48, Воронеж(473)204-51-73, Екатеринбург(343)384-55-89,
Казань(843)206-01-48, Краснодар(861)203-40-90, Красноярск(391)204-63-61, Москва(495)268-04-70,
Нижегород(831)429-08-12, Новосибирск(383)227-86-73, Ростов-на-Дону(863)308-18-15, Самара(846)206-03-16,
Санкт-Петербург(812)309-46-40, Саратов(845)249-38-78, Уфа(347)229-48-12

sst@nt-rt.ru || sartorius.nt-rt.ru

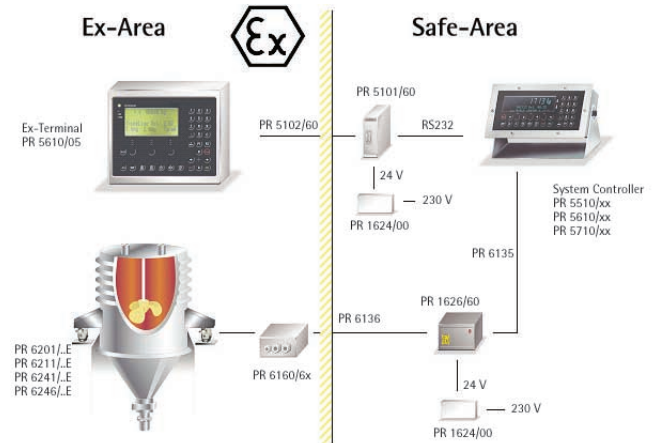
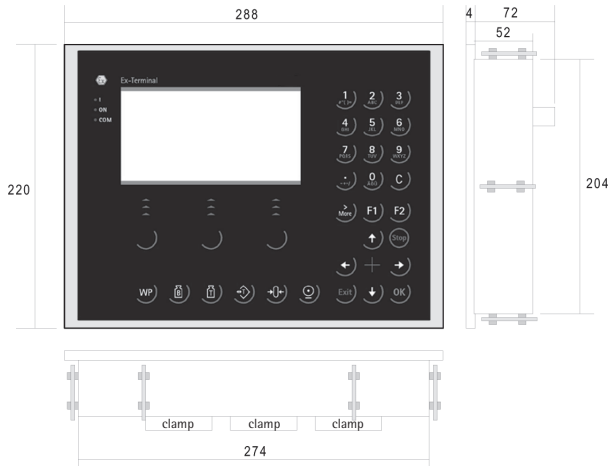

Technical Data

Protection type

according to EN60529/IEC 529
 IP 65 (front)
 IP 20 (housing)
 IP 65 (built into stainless steel housing V2A,
 Option PR5103/60)

Approvals

eigensicher nach Richtlinie 94/9/EG
 (ATEX 100),
 Ex II2G EEx ib IIC T4
 (DMT 02 ATEX E239)

Environmental conditions

Operation: 0°C - +50°C
 Storage: -20°C - +70°C
 rel. humidity: 0% - 75%,
 no condensation, 48h stress test

Front foil

Polyester, printed on back

Front panel frame

Aluminium, black anodized

Keyboard

with tactile feedback

Dimensions

Front panel (W x H): 288 x 220mm
 Cut-Out (W x H): 276 x 208mm
 Exterior depth: 72mm
 incl. clamps, without connector
 Weight: ca. 2kg

Display

LCD, supertwisted nematic,
 without background lighting,
 148mm x 74mm,
 3 lines à 20 characters,
 12mm character height,
 scratch resistant Display,
 anti-reflective coating

Function display

3 LEDs for power supply and error conditions

CE-declaration of conformity

The manufacturer confirms that this product corresponds to the relevant EMV guidelines as per 89/392/EWG. The Ex-Terminal carry the CE marking.

Data interface and power supply PR5101/60 and cable PR5102/60

EX-cable connection schematic of PR 5101/60 and X5-Controller

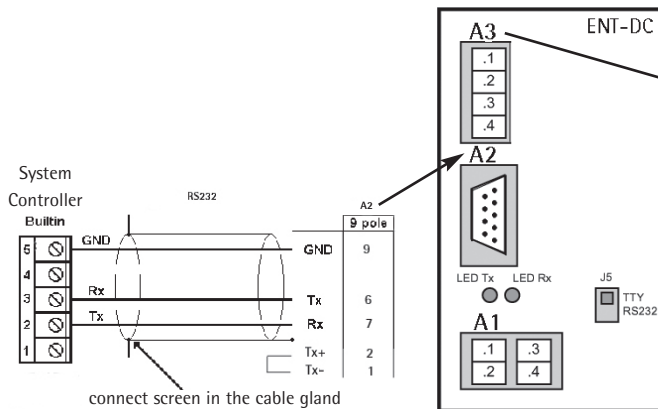

Cable connection schematic of PR5101/60 an Ex-Terminal

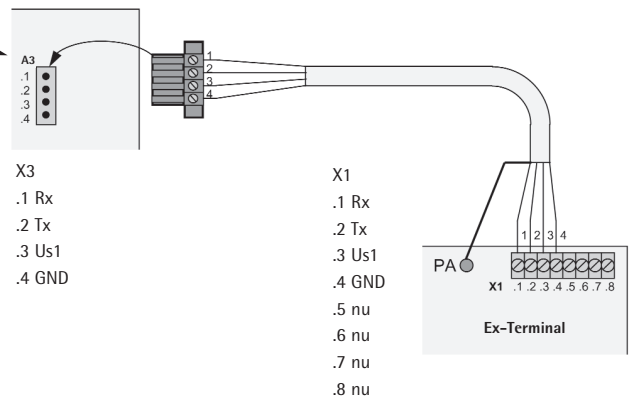

Technical Data

Approvals

eigensicher nach Richtlinie 94/9/EG
(ATEX 100)
II(2)G [Ex ib] IIC
(DMT 03 ATEX E011x)

Housing

DIN rail mounting
material: aluminium
Dimensions: see drawing
weight: ca. 1kg
protection class: IP 20

Environmental conditions

Operation

Temperatur: 0°C - +50°C
rel. humidity: 0% - 85%,
no condensation, 48h stress test

Storage

Temperatur: -20°C - +70°C

Interface parameter:

(Ex-Terminal <-> PR5101/60 <-> X5)

A1 power supply

power 24V_{DC}, -10% + 20%
absolute maximum +32V_{DC}
380mA continuous current
2-pin connectors

A2 data interface

to connect to X5-controller
Data, zero potential RS232 (remote setup)
Default: 9600 Baud, 8 Bit, parity:
none, 1 stop bit
9-pin D-sub connectors

A3 Exi interface

to connect to the Ex-Terminal:
Data 20mA CL
2 x 4-pin connectors

Delivery incl. pin connectors

Cable PR 5102/60

Data- and power supply connection
4 wire cable
diameter 8.7mm
Cable in blue according to VDE 0165
length on request (max. 200m).

Rail mounting housing

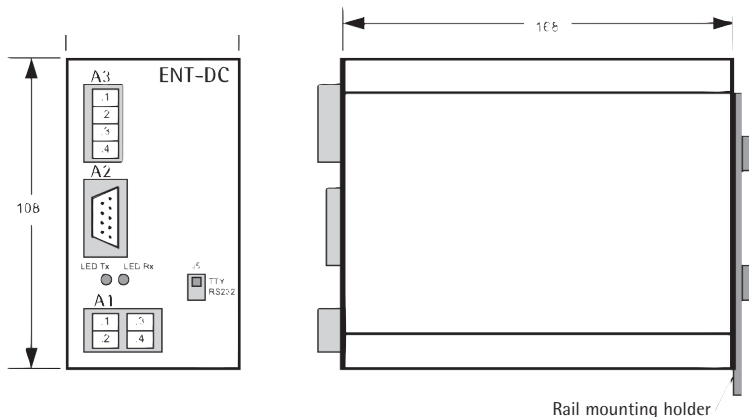

All dimensions in mm

Stainless Steel housing PR5103/60 in IP 65

Used as table top version

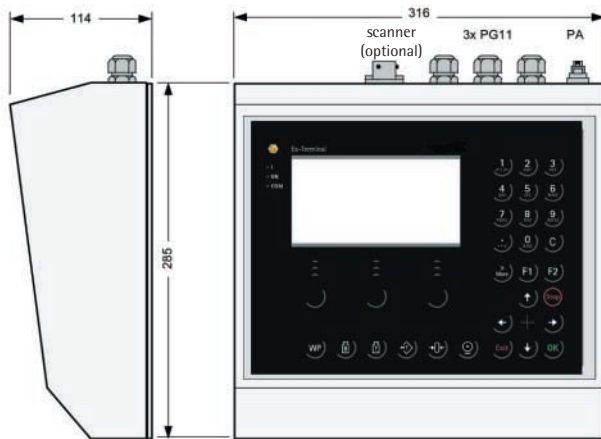

Used as wall mounted version

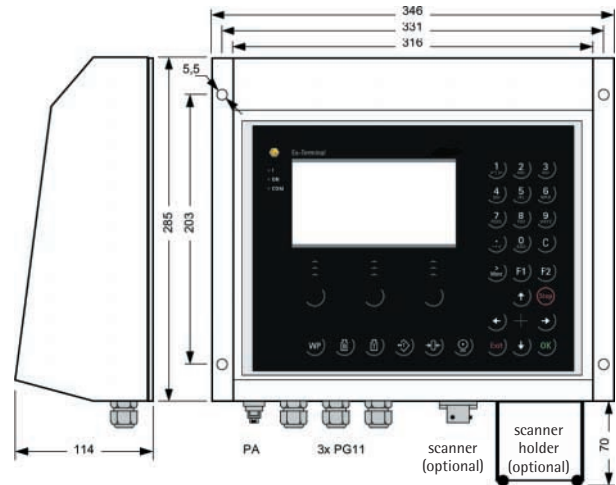

The Ex-Terminal is compatible with all system controllers of the X-Family:

PRO Controller

The Pro Controller is a multiple use device for precise weighing applications for industrial environment.

BATCH Controller

The BATCH Controller is a weighing controller with internal recipe handling to allow automation of batching, manual additions and process control.

FLOW Controller

The FLOW Controller is a feed rate control unit for the direct control of continuous discharge processes from weigh-hoppers.

IBC Controller

The IBC Controller is a powerful control unit for the direct control of automatic loading and discharge processes for IBCs (Intermediate Bulk Containers) with powders or granulated material.

TRUCK Controller

The TRUCK Controller is a weighing controller for weighbridge applications.

LOG Controller

The LOG Controller is a universal weighing controller for weight indication and simple inventory control.

FILL Controller

FILL Controller the automatic controller for filling of fluids.

BULK Controller

The controller for circuit scales.

Order information

Type	Description	Order number
PR5610/05	X5-Ex-Terminal	9405 156 10051
PR5103/60	Housing for X5-Ex-Terminal	9405 351 03601
PR5101/60	Data Interface and power supply	9405 351 01601
PR5102/60	Data cable between Ex-Terminal and Interface	9405 351 02601

По вопросам продаж и поддержки обращайтесь:

Астана+7(7172)727-132, Волгоград(844)278-03-48, Воронеж(473)204-51-73, Екатеринбург(343)384-55-89,
 Казань(843)206-01-48, Краснодар(861)203-40-90, Красноярск(391)204-63-61, Москва(495)268-04-70,
 Нижний Новгород(831)429-08-12, Новосибирск(383)227-86-73, Ростов-на-Дону(863)308-18-15, Самара(846)206-03-16,
 Санкт-Петербург(812)309-46-40, Саратов(845)249-38-78, Уфа(347)229-48-12

sst@nt-rt.ru || sartorius.nt-rt.ru